

GLOW TUBE™

T8-18

INSTALLATION INSTRUCTIONS

PARTS INCLUDED:

- (1) 1 ea. GT1200-T8™ T8-18 GLOW TUBE - (A)
- (2) 1 ea. Wiring harness - (B)
- (3) 2 ea. Wire nuts - (C)

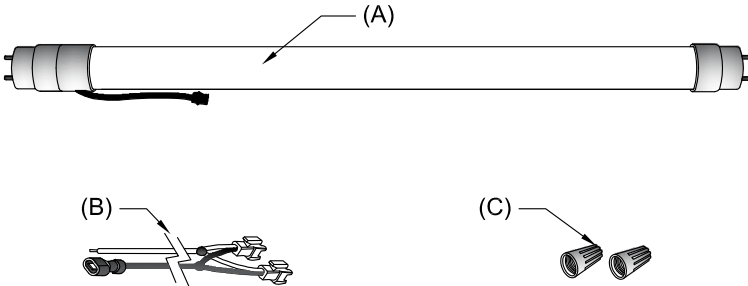

TOOLS REQUIRED:

- Wire cutters
- Wire strippers
- Electrical tape may be necessary to cover sharp edges.

Please read and understand the installation instructions completely before proceeding with the installation.

NOTE: The following instructions should be followed exactly as written for both SINGLE & DOUBLE bulb fixtures. The LED wiring harness included (B) may be used to connect up to 2 LED Bulbs at one time, depending on the lighting fixture it is to be installed in. Both single & dual fixtures require only (1) harness (B). *(PERFORMING THE WIRING INSTALLATION TWICE IS NOT NECESSARY FOR DUAL-BULB-FIXTURES).*

DISCLAIMER: This GLOW TUBE™ was designed for use with 12 volt AC/DC low voltage applications only. The GLOW TUBE™ must be installed in accordance with any state and national codes. Using power other than that specified or modifying the tube in any way may result in a hazard and will VOID THE WARRANTY.

INSTALLATION INSTRUCTIONS

PRE-INSTALLATION INSPECTION: Switch on existing fixture to verify that it is in good working order.

INSTALLATION INSTRUCTIONS:

1. Disconnect the power circuit to the fixture. **DO NOT WORK ON LIVE WIRES AS IT COULD RESULT IN INJURY OR DAMAGE TO THE RV OR BOAT.**

2. Remove the fixture lens and existing fluorescent bulb (**Fig.1**). **TAKE CARE NOT TO BRAKE THE FLUORESCENT BULB AS IT WILL CONTAMINATE THE INSIDE OF YOUR RV OR BOAT WITH HAZARDOUS MERCURY.**

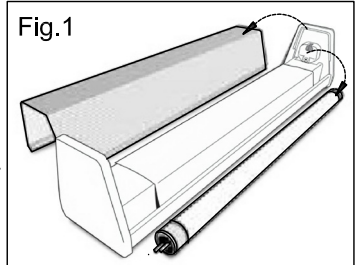

3. Remove metal ballast cover (**Fig.2**) (NOTE: This kit bypasses the fluorescent Ballast and its removal is not necessary)

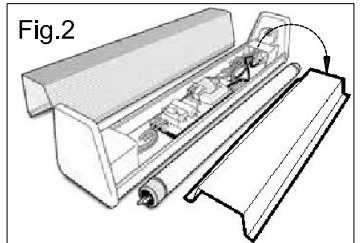

4. Locate the wires entering the fixture. There should be one black (+) that connects to the fixtures switch & one white (-) that that connects to the ballast PCB. (**Fig 3**)

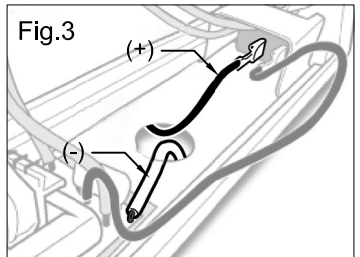

5. Note (**Fig 4**) and disconnect the switched power wire (connects the switch to the ballast PCB). Fold it as shown and place out of the way.

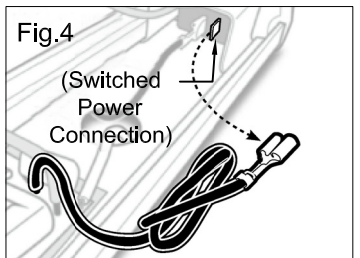

5. Cut the white (-) wire approximately 1" away from the Ballast circuit board as shown in (Fig 5).

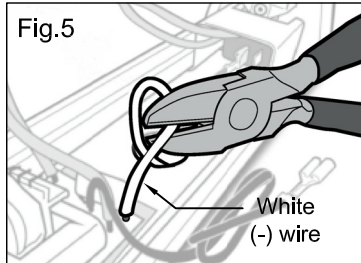

6. Strip the white (-) wire (that part NOT attached to the ballast circuit board) approximately $\frac{1}{4}$ " (Fig 6) NOTE: This is the ground wire coming from the battery of the RV or Boat.

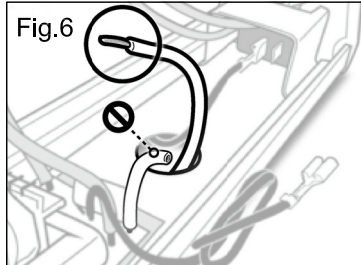

7. Take the provided wiring harness (B) and attach the spade connector to the "switched power side" of the switch as shown in (Fig 7) NOTE: The replacement tubes are 12 volt AC/DC and cannot be wired incorrectly.

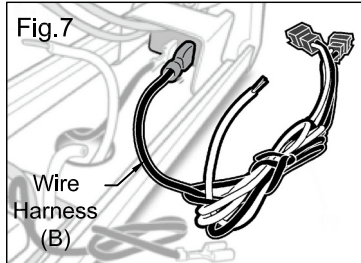

8. Connect the white wire (-) identified and striped in Step 6 to the Wiring Harness (B) using the Wire Nut (C) provided with the kit, see (Fig 8).

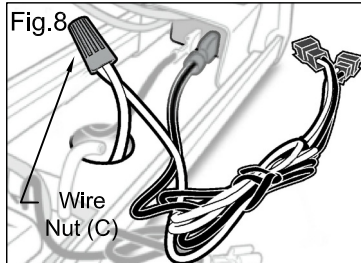

9. Replace the ballast cover. Check to be sure that all wires are tucked neatly underneath except for the plastic harness plug (B). This connector is to be left sticking out (Fig 9). For Dual bulb installations leave both Plugs sticking out.

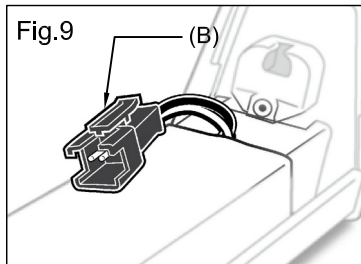

WARNING: Be sure before proceeding to the next step that the Harness (B) is not resting or pinched against any sharp edge that could cut through the protective cover causing a short circuit.

10. Connect the **GT1200-T8™** wiring harness (B) female plastic plug or plugs to the male plastic plug or plugs on the **GT1200-T8™** tube(s) (Fig 10).

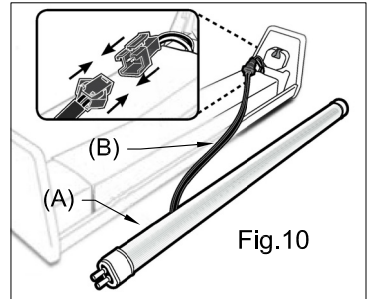

11. Install the **GT1200-T8™** into the fixture (NOTE: The 2 ends ratchet to allow the light to be directed), tuck in the harness (2) behind the tube (1) and replace the lens removed in Step 2.

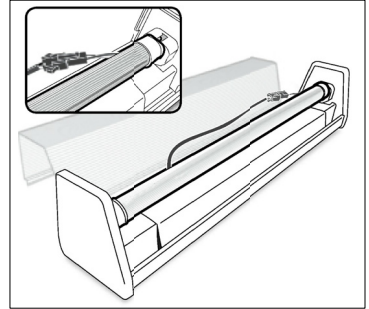

12. Reconnect the power and test to ensure that the **GT1200-T8™** functions with out any problems. Should it not illuminate disconnect the power and recheck all connections and retry. If at this point the **GT1200-T8™** still does not illuminate call for help at the number listed below.



16772 W. Bell Rd, Ste 110-138
Surprise, AZ 85374-9702
(623) 328-9873
info@rvledlites.com
www.rvledlites.com

LIMITED WARRANTY: RV LED Lites warrants this product to be free from defects in material and workmanship under normal use and service for 12 months from date of purchase. RV LED Lites liability is limited solely to the replacement of any defective product returned to us. To the extent allowable by law, RV LED Lites makes no other warranty, either expressed or implied, nor assumes any liability for incidental or consequential damages resulting from the use of this product or for breach of warranty of merchantability or fitness for a particular purpose. Submit warranty claims to RV LED Lites, 16772 W. Bell Rd, Ste 110-138, Surprise, AZ 85374-9702.